

ZEPRO ZNU 45-110

(110 bar)		12 volt	24 volt
Moteur		95 A	60 A
Bobine (G.E.P.)		1,4 A	0,7 A
Bobine (Clapet)		1,5 A	0,75 A
Solénoïd		1,8 A	0,9 A
Surface de câble:	Câble alimentation	1,5 mm ²	1,5 mm ²
	Câble commande 0-8 m	35 mm ²	35 mm ²
	Câble commande 8-15 m	35 mm ²	35 mm ²
	Câble commande >15 m	-	35 mm ²
Batterie:	Capacité min.	140 Ah	110 Ah
	Capacité min.	9 volt	18 volt

Abaque de charge

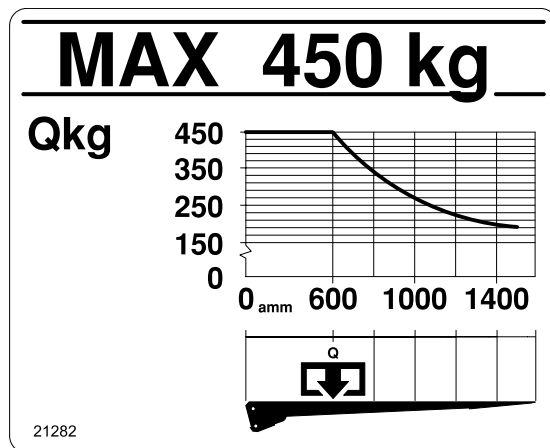

Côtes de montage (mm)

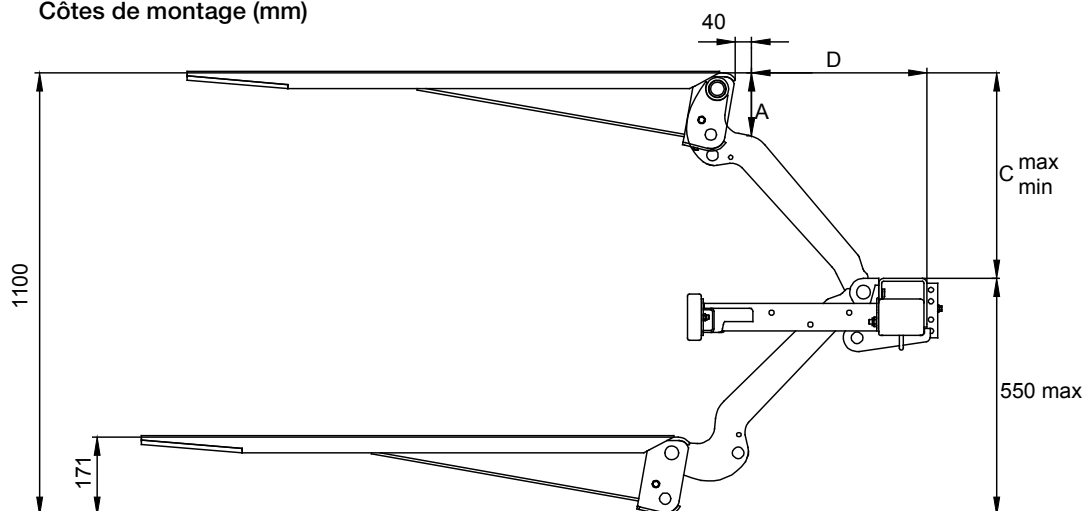

C	A	D
550	146	432
500	133	498
450	125	549
400	117	590
350	105	624
300	95	652
250	85	675

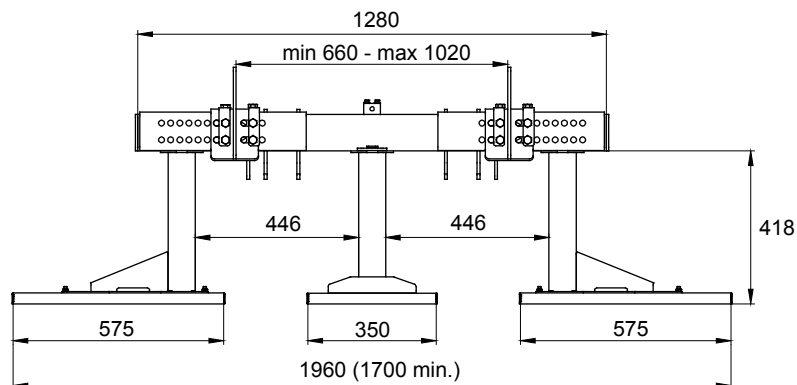
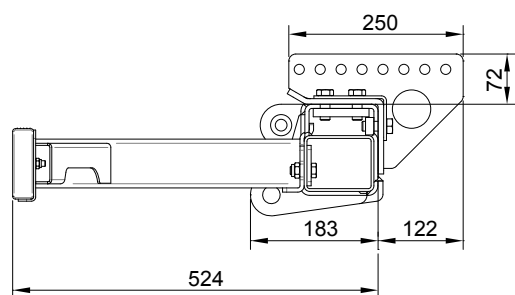

2017-04-25

ZEPRO Sales

Tel.: +46 (0)150 489 550

Fax: +46 (0)150 489 551, +46 (0)150 489 566

E-mail: zepro@zepro.com | zepro.com

