

# ZEPRO ZNU 45-90

Loading diagram

(110 bar)		12 volt	24 volt
Pump – Motor Unit		95 A	60 A
Magnet (hydraulic unit)		1,4 A	0,7 A
Magnet (electric safety valve)		1,5 A	0,75 A
Solenoid		1,8 A	0,9 A
Cable area	Control cable	1,5 mm <sup>2</sup>	1,5 mm <sup>2</sup>
	Main cable 0-8 m	35 mm <sup>2</sup>	35 mm <sup>2</sup>
	Main cable 8-15 m	35 mm <sup>2</sup>	35 mm <sup>2</sup>
	Main cable >15 m	-	35 mm <sup>2</sup>
Power source	Min. capacity	140 Ah	110 Ah
	Min. voltage	9 volt	18 volt

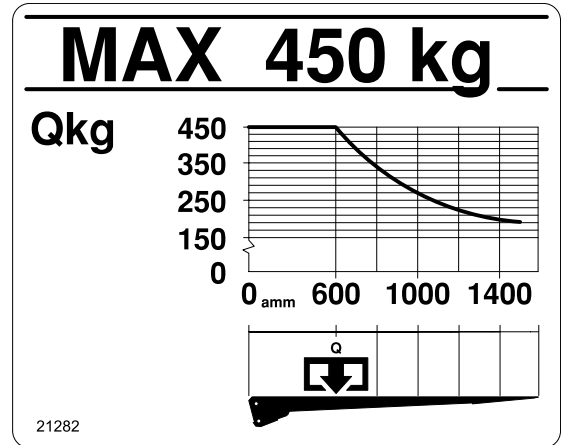

Installation dimensions (mm)

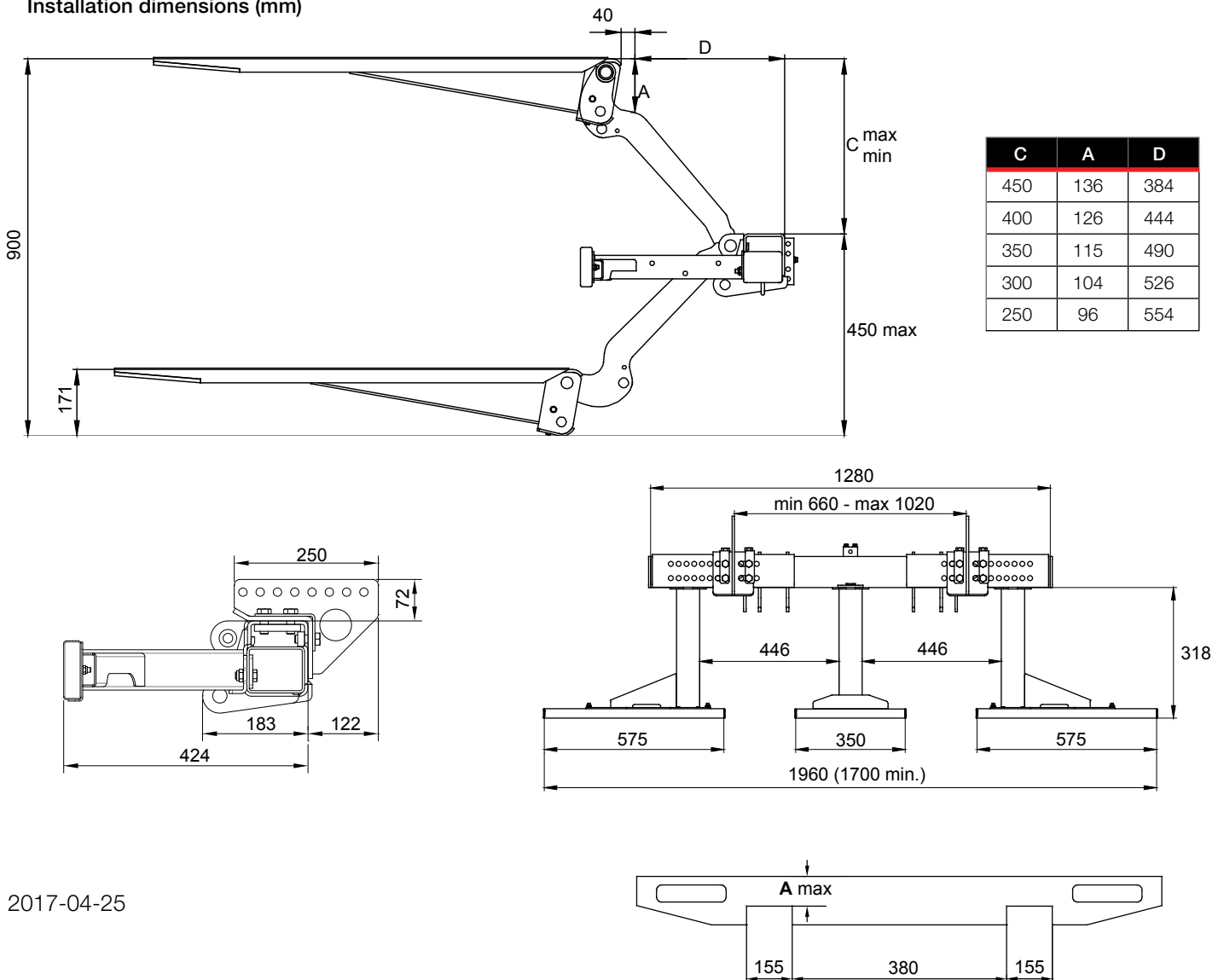

2017-04-25

## ZEPRO Sales

Tel.: +46 (0)150 489 550

Fax: +46 (0)150 489 551, +46 (0)150 489 566

E-mail: [zepro@zepro.com](mailto:zepro@zepro.com) | [zepro.com](http://zepro.com)