

HIAB 027 Capacity 3 tm

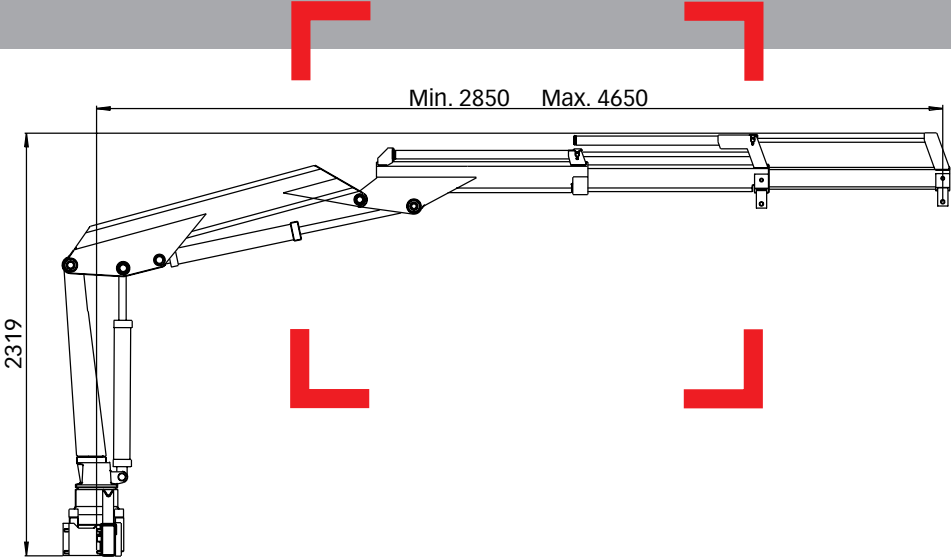

Basic data

HIAB 027 Basic data

Technical data

	027-1	027-2
Max. lifting capacity (kNm)	26.9	26.3
Outreach - hydraulic extensions (m)	3.7	4.7
Outreach - manual extensions (m)	5.7	5.7
Outreach / lifting capacity (m / kg)	1.5 / 1800*	1.4 / 1800*
	2.7 / 998	2.9 / 920
	3.5 / 780	3.8 / 700
	-	4.5 / 540
Slewing angle	330°	330°
Height in folded position (mm)	1640	1640
Width in folded position (mm)	1680	1680
Installation space needed (mm)	-	-
Weight - "standard" crane without stabilizers (kg)	340	370
Weight - stabilizer equipment (kg)	63 - 113	63 - 113

* May require special hook or special hook position

HIAB 027-2

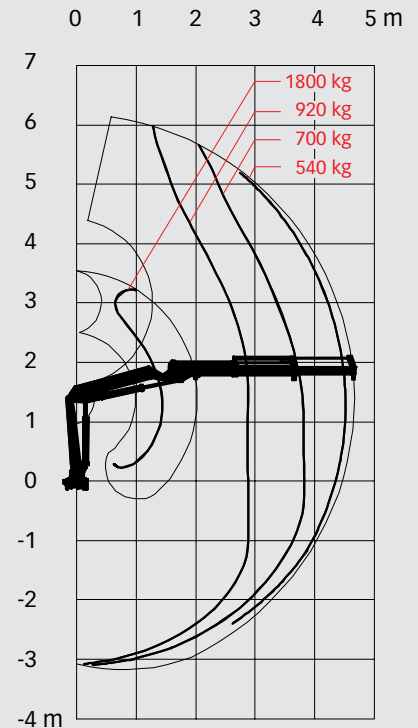
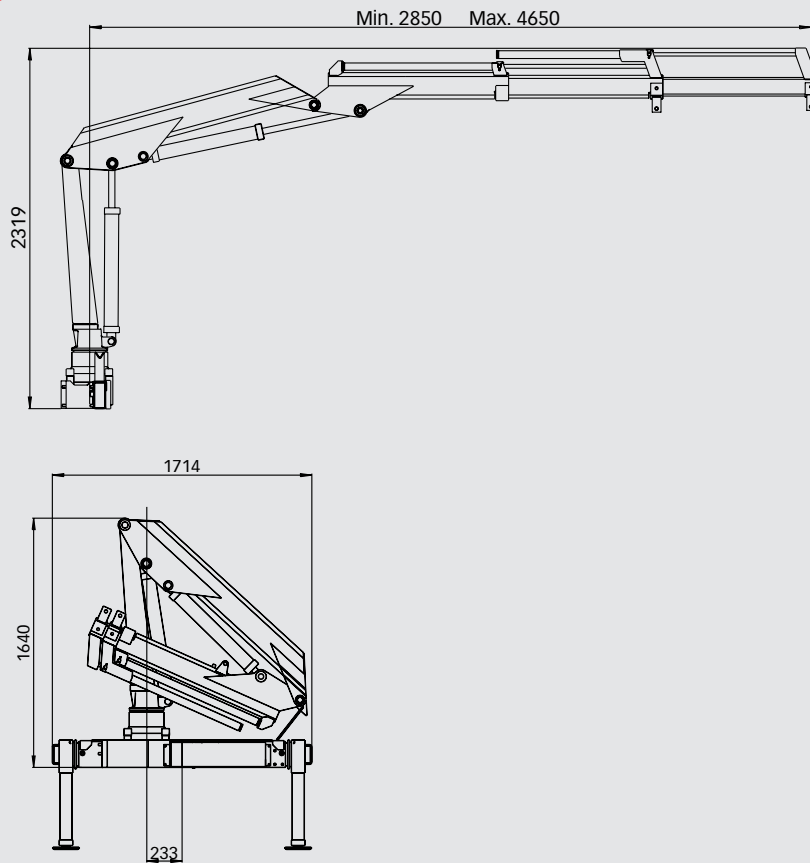

Disclaimer

Hiab cranes has been built to meet the highest standards of safety and service life and has been thoroughly tested. Strength calculations for this model have been carried out in accordance with DIN 15018. Hiab's certified Quality Assurance System complies with the ISO 9001. Some of the items in our literature may be extra equipment. Certain applications may require an official permit. We reserve the right to change technical specifications without prior notice. Hiab cranes produced for EU-countries are CE-marked and comply with the European Standard EN 12999.