

ZEPRO Z 15-130

Loading diagram

(170 bar)		12 volt	24 volt
Pump - Motor Unit		220 A	120 A
Lowering valve		1,4 A	0,7 A
Shift valve		3,8 A	2,0 A
Magnet (electric safety valve)		1,5 A	0,75 A
Solenoid		1,8 A	0,9 A
Cable areas:	Control cable	1,5 mm ²	1,5 mm ²
	Main cable 0-8 m	35 mm ²	35 mm ²
	Main cable 8-15 m	35 mm ²	35 mm ²
	Main cable >15 m	-	35 mm ²
Power source:	Min. capacity	180 Ah	170 Ah
	Min. voltage	9 volt	18 volt

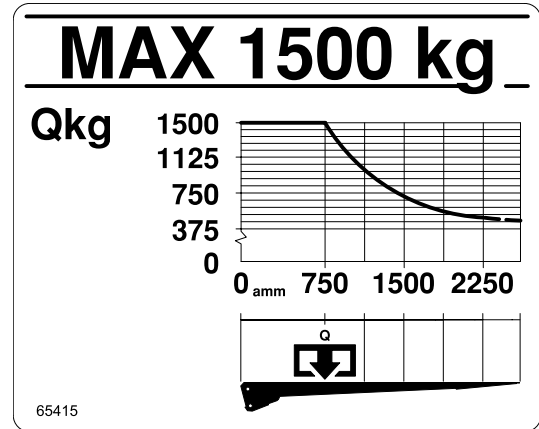

Installation dimensions (mm)

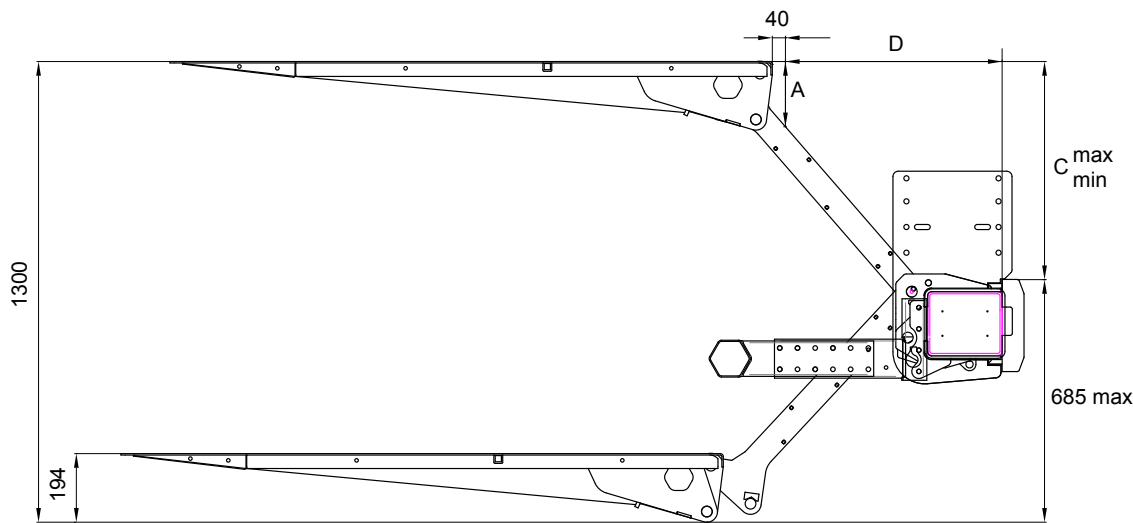

C	A	D
615	188	608
550	158	689
500	142	738
450	130	779
400	120	814
350	111	843
300	103	867
285	101	873

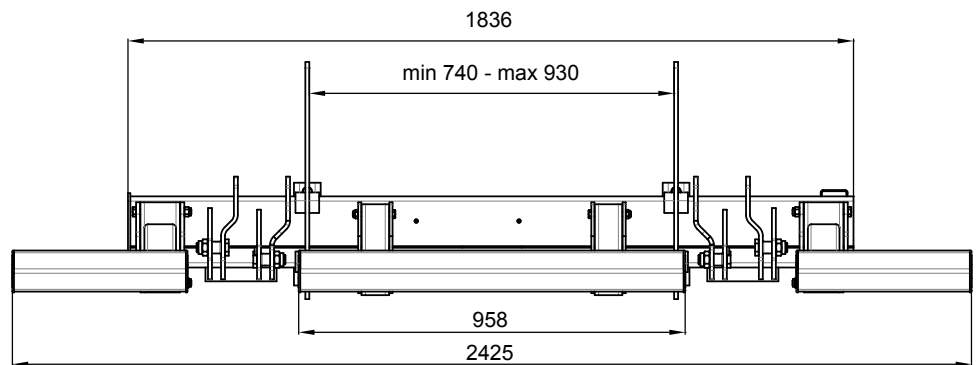
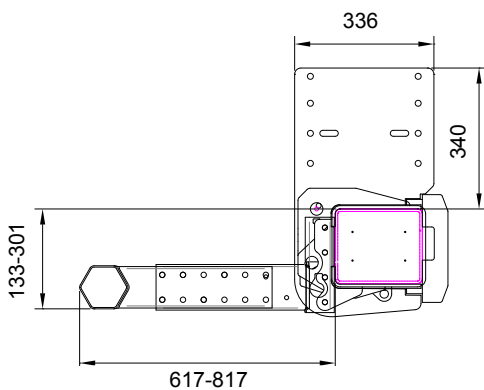

2014-04-14

ZEPRO Sales

Tel.: +46 (0)150 489 550
 Fax: +46 (0)150 489 551, +46 (0)150 489 566
 E-mail: zepro@zepro.com | zepro.com

